

CODE NUMBER

3072609

DESCRIPTION

0.5 gpf, XL Sweat Solder Adapter Kit, Polished Chrome Finish, Single Flush, GEM-2® Exposed Manual Urinal Flushometer.

DETAILS

- Flush Volume: 0.5 gpf (1.9 Lpf)
- Finish: Polished Chrome (CP)
- Valve: Piston
- Valve Body Material: Semi-red Brass
- Fixture Type: Urinal
- Fixture Connection: Top spud
- Rough-In Dimension: 11 ½" (292mm)
- Spud Coupling: ¾" (19mm)
- Supply Pipe: ¾" (19mm)
- Adapter: XL Sweat Solder Adapter Kit (XL)

FEATURES

- Fixed Volume Piston with Filtered O-ring Bypass
- ADA Compliant Metal Oscillating Non-Hold-Open Handle
- ¾" I.P.S. Screwdriver Bak-Chek® Angle Stop with Control Stop Plug
- Vacuum Breaker Flush Connection
- Spud Coupling, Wall and Spud Flanges for ¾" Top Spud
- Cast Wall Flange with Set Screw
- Sweat Solder Adapter with Cover Tube
- Non-Hold-Open Handle and No External Volume Adjustment to Ensure Water Conservation
- Handle Packing, Stop Seat and Vacuum Breaker Molded from PERMEX® Rubber Compound for Chloramine Resistance



COMPLIANCES & CERTIFICATIONS

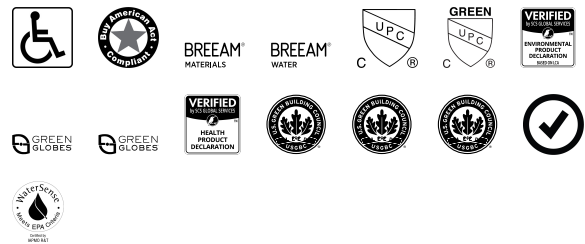

(ADA Compliant, BAA Compliant, BREEAM Materials Credit, BREEAM Water Credit, cUPC Certified, cUPC Green Certified, EPD, Green Globes Materials & Resources Credit, Green Globes Water Credit, HPD, LEED Materials & Resources EPD Credit, LEED Materials & Resources HPD Credit, LEED V4 Water Efficiency Credit, Satisfies LEED Credits, WaterSense Listed)

RECOMMENDED SPECIFICATION

Valve Body, Cover, Tailpiece and Control Stop shall be in conformance with ASTM Alloy Classification for Semi- Red Brass. Valve shall be in compliance with the applicable sections of ASSE 1037 and ANSI/ASME 112.19.2.

VALVE OPERATING PRESSURE (FLOWING)

15-80 PSI (103-552 kPa). Specific fixtures may require greater minimum flowing pressure - consult manufacturer requirements.

DOWNLOADS

- [GEM/GEM 2 Piston Type Exposed Installation Instructions](#)
- [Control Stop Repair and Maintenance Guide](#)
- [Flush Connections Flanges Repair and Maintenance Guide](#)
- [Tail Piece Repair and Maintenance Guide](#)
- [Gem 2 Repair and Maintenance Guide](#)
- [Additional Downloads](#)

NOTES

All information contained within this document subject to change without notice.

Looking for other variations of the GEM-2 186 product? [View the general spec sheet with all options.](#)

Sloan 10500 Seymour Ave, Franklin Park, IL 60131

Phone: 800.982.5839 • Fax: 800.447.8329 • sloan.com

Find a compatible urinal for this flushometer.
 Find a compatible water closet for this flushometer.
 Watersense compliant when used with a WaterSense compliant fixture

ROUGH-IN

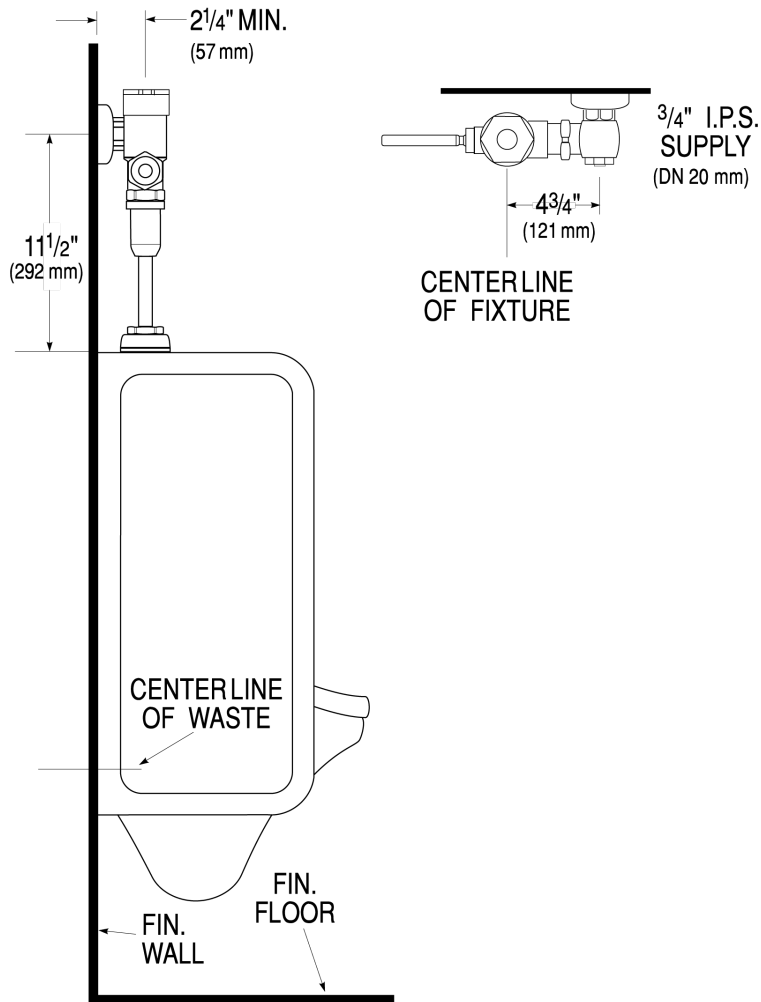

Sloan 10500 Seymour Ave, Franklin Park, IL 60131
 Phone: 800.982.5839 • Fax: 800.447.8329 • sloan.com