

#### Features

- Left-hand trip lever.
- Premium metal construction for durability.
- KOHLER finishes resist corrosion and tarnish.
- For use with the Memoirs Comfort Height toilet.
- Coordinates with other products in the Memoirs Collection.



ADA

#### Codes/Standards







ASME A112.18.1/CSA B125.1  
ADA  
ICC/ANSI A117.1

#### KOHLER® One-Year Limited Warranty

See website for detailed warranty information.

#### Available Color/Finishes

*Color tiles intended for reference only.*

| Color  | Code | Description              |
|--|------|--------------------------|
|  | SN   | Vibrant® Polished Nickel |
|  | AF   | Vibrant® French Gold     |
|  | PB   | Vibrant® Polished Brass  |
|  | G    | Brushed Chrome           |
|  | BN   | Vibrant® Brushed Nickel  |
|  | BV   | Vibrant® Brushed Bronze  |
|  | 2BZ  | Oil-Rubbed Bronze        |
|  | BL   | Matte Black              |
|  | RGD  | Vibrant Rose Gold        |
|  | VNT  | Vintage Nickel           |

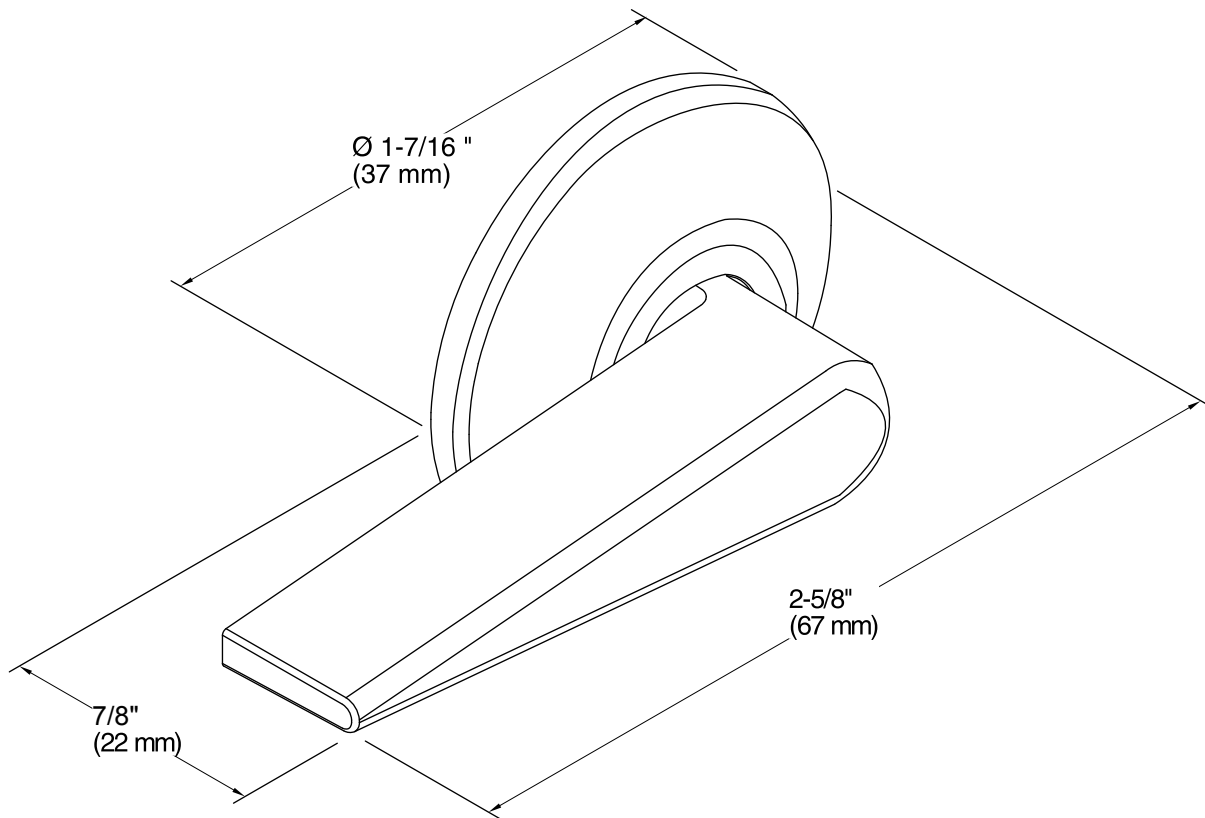

#### Technical Information

All product dimensions are nominal.

#### Notes

ADA compliant when installed to the specific requirements of these regulations.